

Power Inductor

BMMA Series



Overview

BMMA Series is designed for low profile type with low RDC and ultra large current. Its molded magnetic shielded type is suitable for high-density mounting and ultra low buzz noise. Soldering conditions can be easily confirmed when mounting onto the board. This series also provides customers with embossed carrier type packaging for automatic mounting machine.

Benefits

1. Low resistance and high current rating
2. Magnetic core made by high performance magnetic powder

Applications

1. High current power supplies
2. PMIC
3. DC-DC converters, inverters
4. Consumer Electronics: Smartphones, laptops, tablets, wearable devices, and gaming consoles.

Product Information

Series	L (mm)	W(mm)	T (mm)	Inductance (μH)
BMMA	4	4	1.2	0.047 ~ 15
	4.0	4	2.0	
	5.18	5.49	1.2 ~ 3.0	
	6.47	6.86	1.8 ~ 5	
	8.1	8.3	3 ~ 4	
	10	11.5	1.5 ~ 5	
	12.9	13.2	3.5 ~ 6.4	
	17.2	17.6	7.0	



BMMA00131335 Series Specification

1 Scope This specification applies to large current and low loss SMD power inductor

2 Part numbering

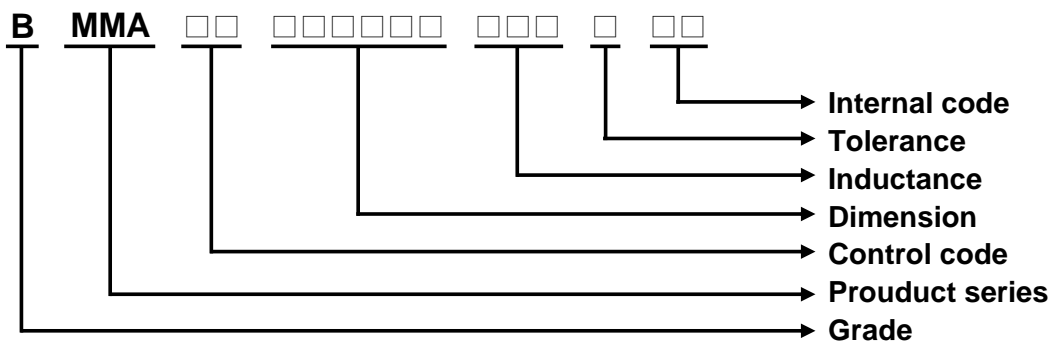

3 Temperature rating

Operating Temperature: -55°C~125°C

Storage Temperature: (on tape & reel): -20°C to +40°C; 75% RH max.

4 Marking

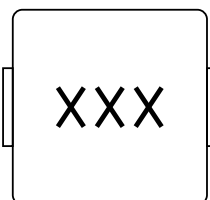

Marking : R15

5 Standard testing condition

	Unless otherwise specified	In case of doubt
Temperature	Ordinary Temperature(15 to 35°C)	20 to 30°C
Humidity	Ordinary Humidity(25 to 85% RH)	50 to 80 %RH

BMMA00131335 Series Specification

6 Configuration and dimensions

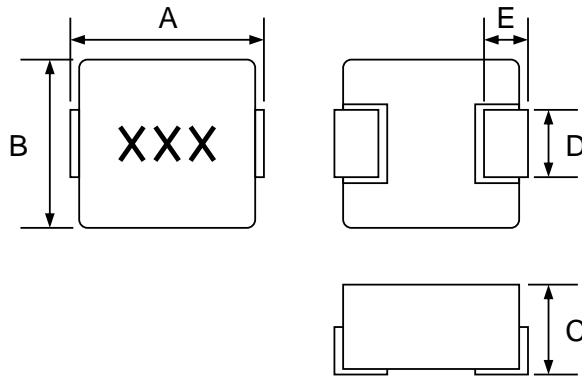

Dimensions in mm

Type	131335
A	13.2 ± 0.5
B	12.9 Max
C	3.5 Max
D	3.5 ± 0.5
E	2.3 ± 0.3

Size Code	Net weight(grms)
131335	3.35 (typ.)

7 Electrical characteristics

Part number	Inductance (uH)	Tolerance (±%)	Test Freq.	I _{rms} (A) Typ.	I _{sat} (A) Typ.	RDC (mΩ) Max.(Typ.)	Marking
BMMA00131335R15MV1	0.15	20	100kHz,0.5V	41	75	1.2(1)	R15
BMMA00131335R22MV1	0.22	20	100kHz,0.5V	38.5	65	1.3(1.1)	R22
BMMA00131335R33MV1	0.33	20	100kHz,0.5V	36.5	62	1.5(1.3)	R33
BMMA00131335R47MV1	0.47	20	100kHz,0.5V	32	55	2(1.6)	R47
BMMA00131335R60MV1	0.6	20	100kHz,0.5V	29	51	2.2(1.8)	R60
BMMA00131335R68MV1	0.68	20	100kHz,0.5V	28	49	2.5(2.3)	R68
BMMA00131335R82MV1	0.82	20	100kHz,0.5V	25	44	3(2.6)	R82
BMMA001313351R0MV1	1	20	100kHz,0.5V	24	40	3.5(3.3)	1R0
BMMA001313351R5MV1	1.5	20	100kHz,0.5V	19	35	5.5(5.1)	1R5
BMMA001313351R8MV1	1.8	20	100kHz,0.5V	16.5	30	7(6.5)	1R8
BMMA001313352R2MV1	2.2	20	100kHz,0.5V	16	29	8(7.2)	2R2
BMMA001313353R3MV1	3.3	20	100kHz,0.5V	12	27	12(11)	3R3
BMMA001313354R7MV1	4.7	20	100kHz,0.5V	10	24	15(14.3)	4R7
BMMA001313355R6MV1	5.6	20	100kHz,0.5V	9.5	19	19(18.3)	5R6
BMMA001313356R8MV1	6.8	20	100kHz,0.5V	9	18	22(19.8)	6R8
BMMA001313358R2MV1	8.2	20	100kHz,0.5V	8.5	16	28(24.8)	8R2
BMMA00131335100MV1	10	20	100kHz,0.5V	7	14	34(30.4)	100

Note:

- Operating temperature range -55°C to 125°C.
- I_{sat} for Inductance drop 20% from its value without current.
- I_{rms} for a 40°C temperature rise from 25°C ambient.
- The part temperature (ambient + temp rise) should not exceed 125°C under worst case operating conditions. Circuit design 125°C under worst case operating conditions. Component placement, PCB trace size and thickness, airflow and other cooling provisions all affect the part temperature. Part temperature should be verified in the end application.
- Absolute maximum voltage 25V DC. (Based on test method, it may not be the same under different application, it is recommended to verify first.)

BMMA00131335 Series Specification

8 BMMA00131335 Series

8.1 Construction

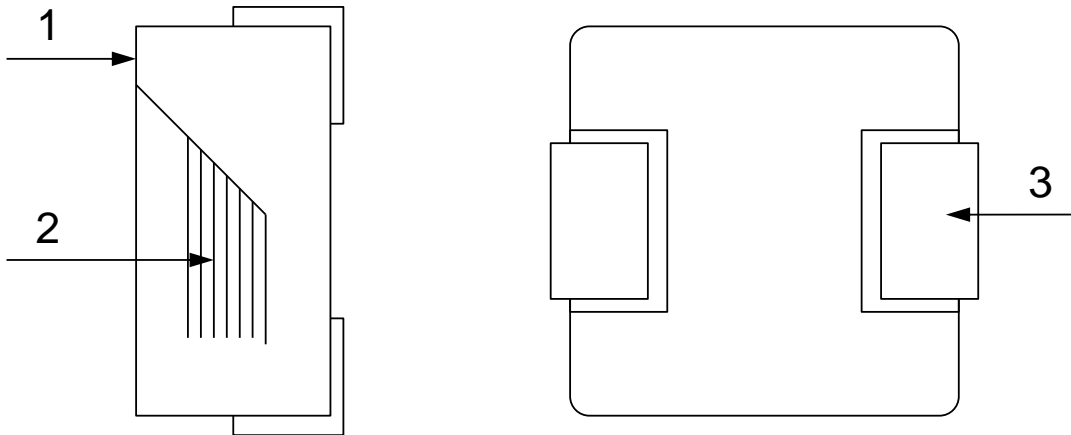

8.2 Material List

Item	Part	Description
1	Magnetic core	Magnetic metal powder
2	Coil	Enameled copper wire
3	Terminals	Copper based terminal

BMMA00131335 Series Specification

9 Reliability test items

1-1.Mechanical Performance

No	Item	Specification	Test Method
1-1-1	Vibration	Appearance: No damage Inductance: within $\pm 10\%$ of initial value	Test device shall be soldered on the substrate Oscillation Frequency: 10 to 55 to 10Hz for 1min Amplitude: 1.5mm Time: 2hrs for each axis (X, Y & Z), total 6hrs
1-1-2	Resistance to Soldering Heat	Appearance: No damage	Pre-heating: 150°C, 1min Solder Composition: Sn/Ag3.0/Cu0.5 Solder Temperature: 260 \pm 5°C Immersion Time: 10 \pm 1sec
1-1-3	Solder ability	The electrodes shall be at least 95% covered with new solder coating	Pre-heating: 150°C, 1min Solder Composition: Sn/Ag3.0/Cu0.5 Solder Temperature: 245 \pm 5°C Immersion Time: 4 \pm 1sec
1-1-4	Resistance to solvent	There must be no change in appearance or obliteration of marking.	Inductors must withstand 6 minutes of alcohol or water.

1-2.Environmental Performance

No	Item	Specification	Test Method														
1-2-1	Temperature Shock	Appearance: No damage Inductance: within $\pm 10\%$ of initial value	10 cycles (Air to Air) 1 cycles shall consist of: 30 minutes exposure to -55°C 30 minutes exposure to 125°C 15 seconds maximum transition between temperatures														
1-2-2	Temperature Cycle		One cycle: <table border="1" style="width: 100%; border-collapse: collapse;"> <thead> <tr> <th>Step</th> <th>Temperature (°C)</th> <th>Time (min)</th> </tr> </thead> <tbody> <tr> <td>1</td> <td>-55\pm3</td> <td>30</td> </tr> <tr> <td>2</td> <td>25\pm2</td> <td>3</td> </tr> <tr> <td>3</td> <td>125\pm3</td> <td>30</td> </tr> <tr> <td>4</td> <td>25\pm2</td> <td>3</td> </tr> </tbody> </table>	Step	Temperature (°C)	Time (min)	1	-55 \pm 3	30	2	25 \pm 2	3	3	125 \pm 3	30	4	25 \pm 2
Step	Temperature (°C)	Time (min)															
1	-55 \pm 3	30															
2	25 \pm 2	3															
3	125 \pm 3	30															
4	25 \pm 2	3															
1-2-3	Humidity Resistance		Temperature: 40 \pm 2°C Relative Humidity: 90 ~ 95% Time: 1000hrs Measured after exposure in the room condition for 24hrs														
1-2-4	Heat Life		Temperature: 85 \pm 3°C Relative Humidity: 20% Applied Current: Rated Current Time: 1000hrs Measured after exposure in the room condition for 24hrs														
1-2-5	Cold Resistance		Temperature: -55 \pm 3°C Relative Humidity: 0% Time: 1000hrs Measured after exposure in the room condition for 24hrs														

BMMA00131335 Series Specification

10 Recommended IR reflow profile

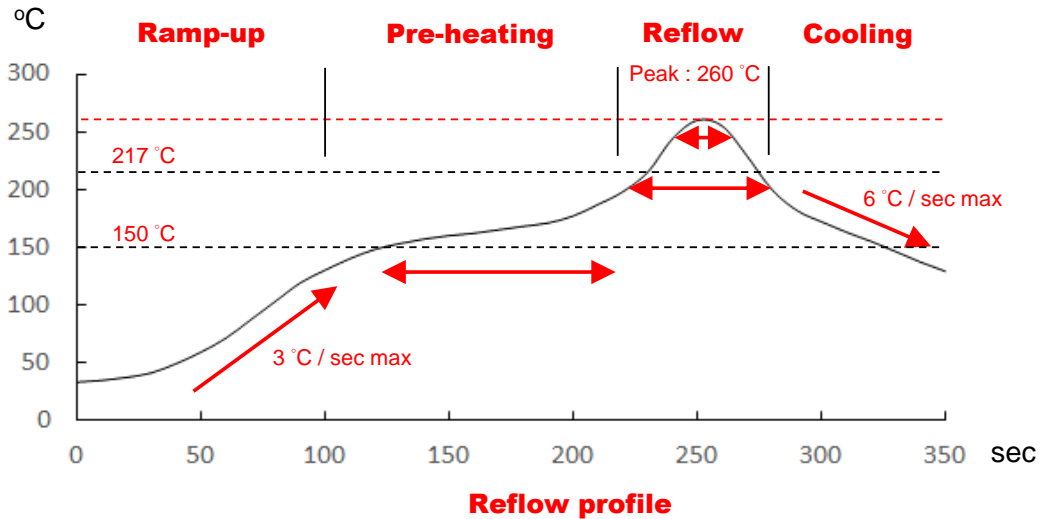

Lead-Free(LF)

Refer to J-STD-020F

Item	Ramp-up	Pre-heating	Reflow	Peak Temp.	Cooling
Temp. scope	R.T. ~150 °C	150 °C~200 °C	217 °C	260±5 °C	Peak Temp. 150 °C
Time spec	-	60~120 sec	60~150 sec	20~40 sec	-

Note:

1. IR reflow times: within 3 times
2. Nitrogen adopted is recommended while in IR reflow

BMMA00131335 Series Specification

11 Packaging

11.1 Packaging-cover tape

The force for tearing off cover tape is 10 to 130 grams.

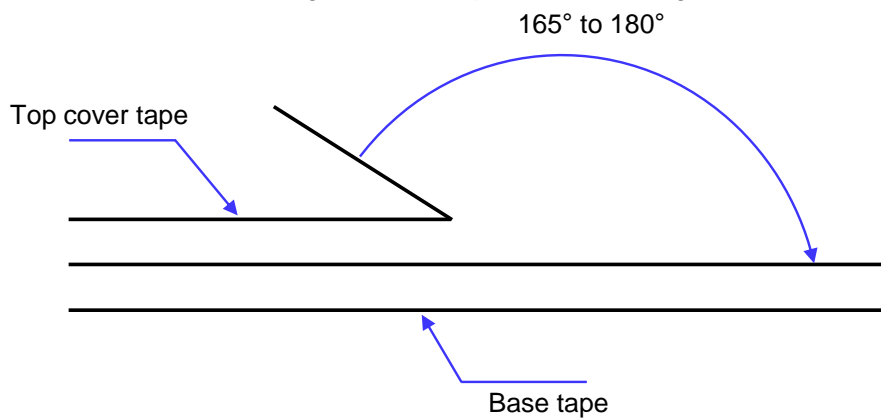

11.2 Packaging quantity

Type	pcs/reel
131335	500

11.3 Reel dimensions

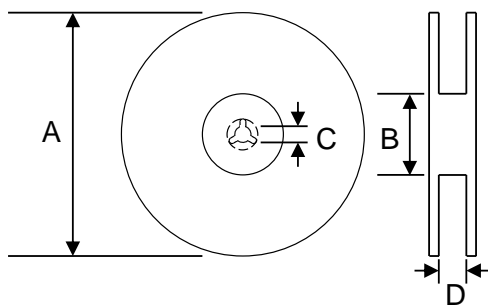

Dimensions in mm

Type	A	B	C	D
131335	330	100	13	24.2

BMMA00131335 Series Specification

11 Packaging

11.4 Tape dimensions in mm

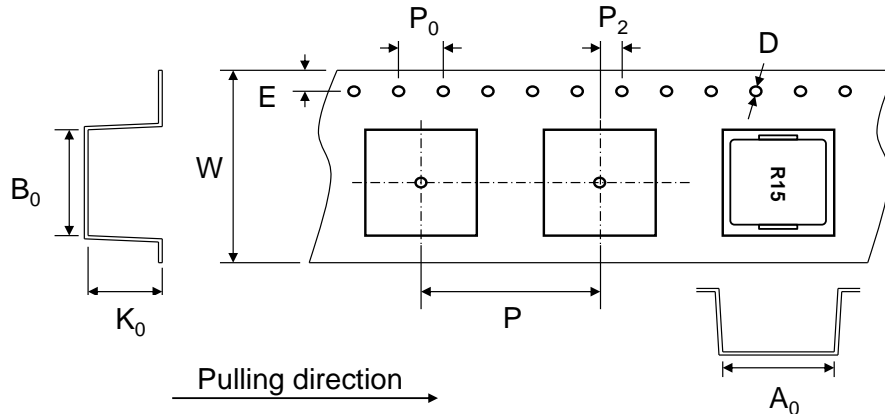

Type	A ₀	B ₀	K ₀	D	E	W	P	P ₀	P ₂
131335	13.0	13.9	3.8	1.5	1.75	24	16	4	2

12 Recommended pattern

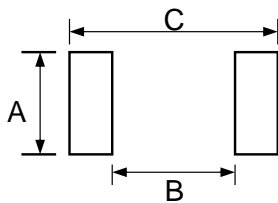

Dimensions in mm

Type	A	B	C
131335	4.0	7.87	13.76

13 Note

1. Please make sure that your product has been evaluated and confirmed against your specifications when our product is mounted to your product.
2. Don't design/mount any components in contact with this product.
3. The moisture sensitivity level (MSL) of products is classified as level 1.
4. Shelf life: 1 years from the date of shipment.

BMMA00131335 Series Specification

14 Graph

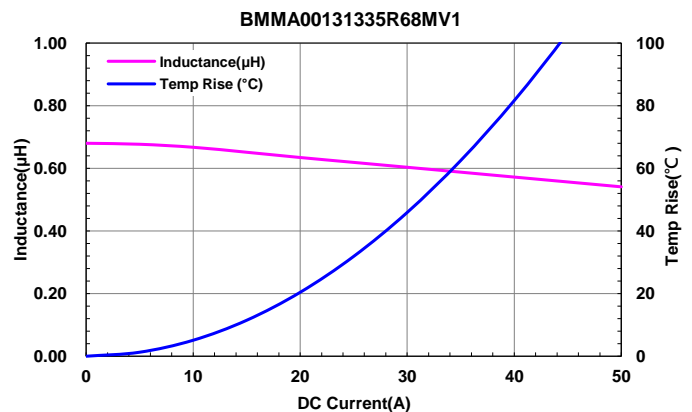
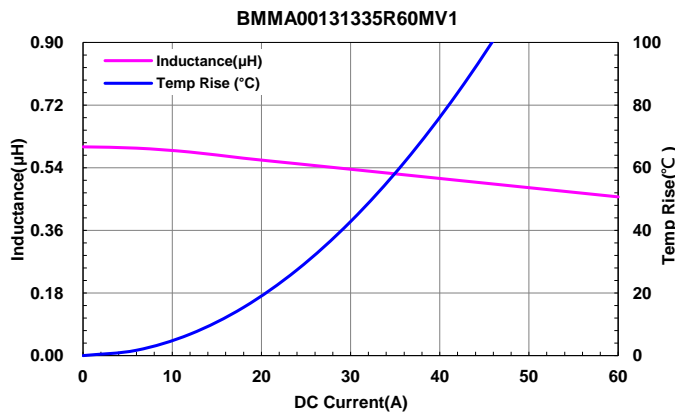
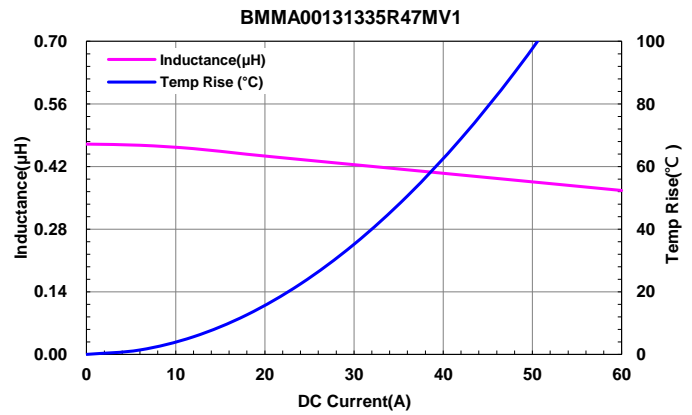
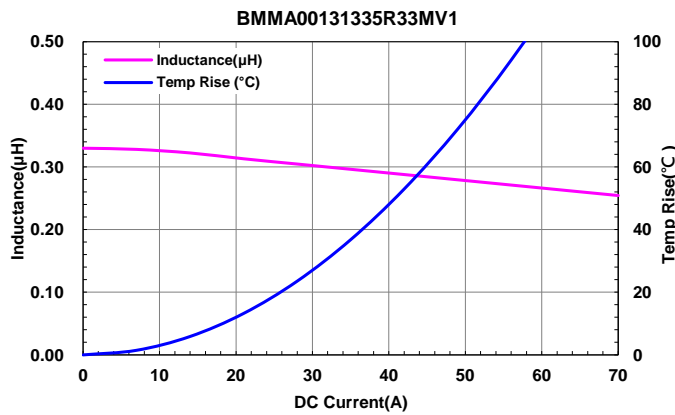
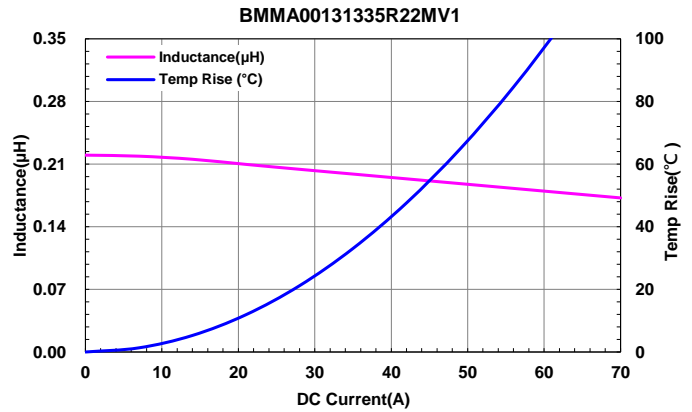
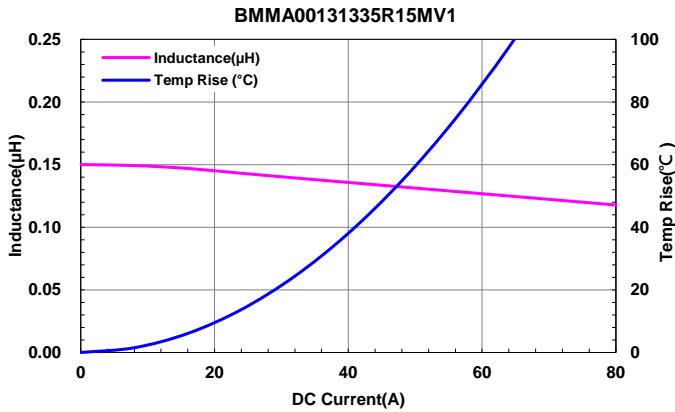

BMMA00131335 Series Specification

14 Graph

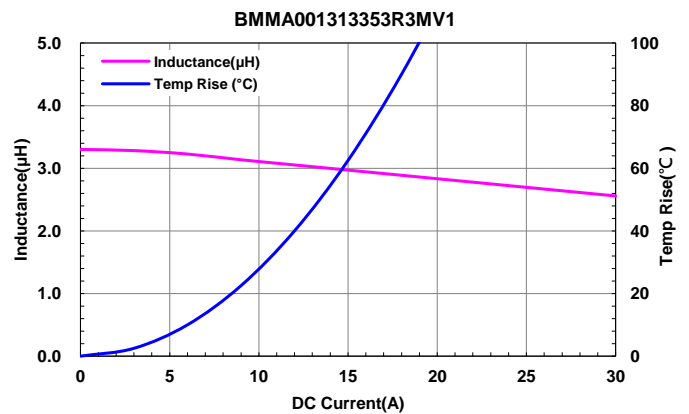
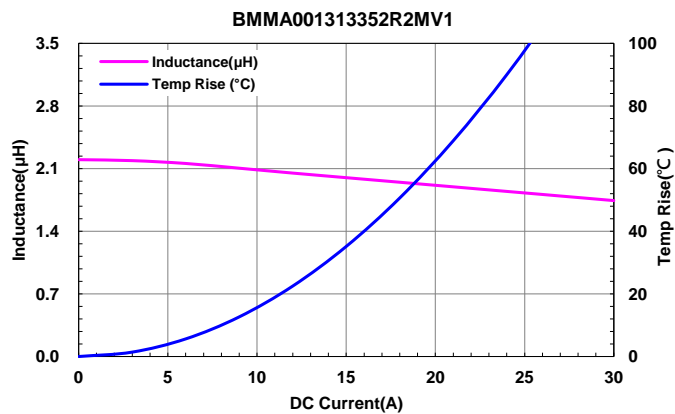
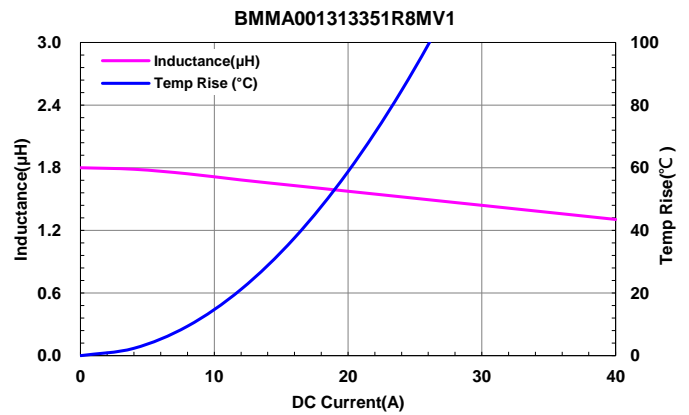
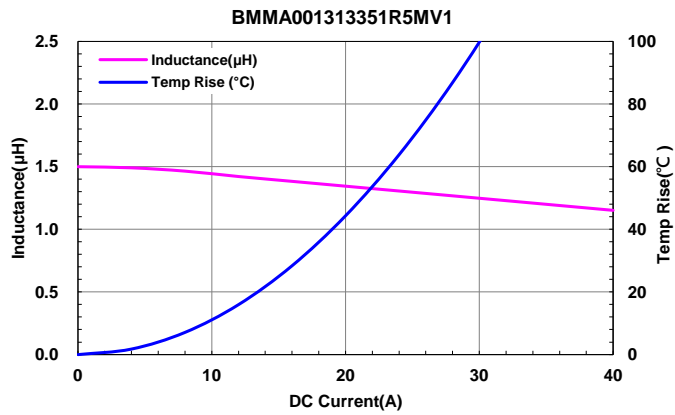
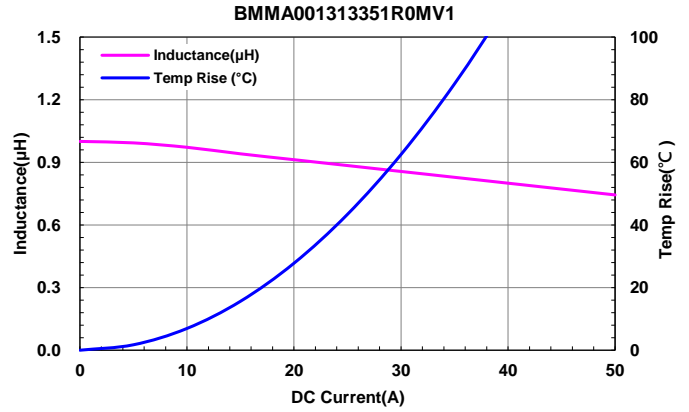
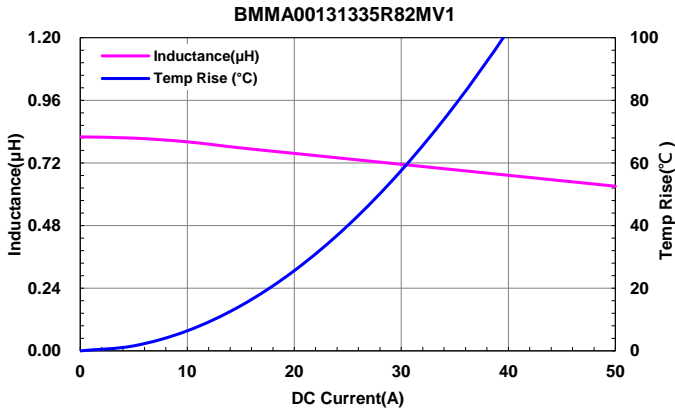

BMMA00131335 Series Specification

14 Graph

