

# Power Inductor

## BPSF Series



### Overview

Power inductors are passive electronic components used in various circuits to store energy in a magnetic field when electrical current flows through them. They are critical in filtering, energy storage, and noise suppression in power electronic systems. They are designed to handle higher currents and are optimized for minimal power loss and thermal efficiency.

### Benefits

1. Ferrite SMD Shielded Type
2. Various package size and wide inductance range

### Applications

1. AP Routers, STBs
2. LCD TVs and monitors
3. Game consoles
4. LED lights
5. DC/DC converters

### Product Information

Series	L (mm)	W(mm)	T (mm)	Inductance (μH)
BPSF	6.0	6.0	2.8	1.2 ~ 1500
	7.0	7.0	2.8	
	7.0	7.0	30.0	
	7.0	7.0	3.2	
	7.0	7.0	4.5	
	7.0	7.0	5.5	
	10.1	10.1	4.5	
	10.1	10.1	5.8	
	12.5	12.5	5.5	
	12.5	12.5	6.5	
	12.5	12.5	7.5	



## BPSF00060628 Series Specification

**1 Scope:** This specification applies to SMD Shielded Power Inductors

**2 Part Numbering:**

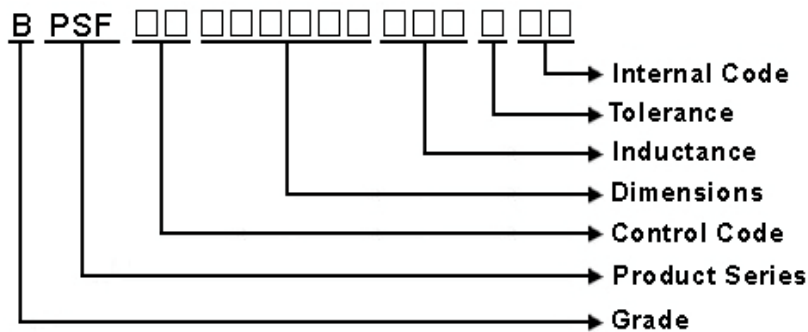

**3 Rating:**

Operating Temperature:  $-40^{\circ}\text{C} \sim +125^{\circ}\text{C}$  (Including self temp. rise)

Storage Temperature:  $-40^{\circ}\text{C} \sim +125^{\circ}\text{C}$  (For after the circuit board is mounted)

Storage Temperature: (on tape & reel):  $-20^{\circ}\text{C}$  to  $+40^{\circ}\text{C}$ ; 75% RH max.

**4 Marking:**



**Ex Marking : 100**

**Marking color : Black**

**5 Standard Testing Condition**

	Unless otherwise specified	In case of doubt
Temperature	Ordinary Temperature(15 to 35°C)	20 to 30°C
Humidity	Ordinary Humidity(25 to 85% RH)	50 to 80 %RH

## BPSF00060628 Series Specification

### 6 Configuration and Dimensions and Unit Weight:

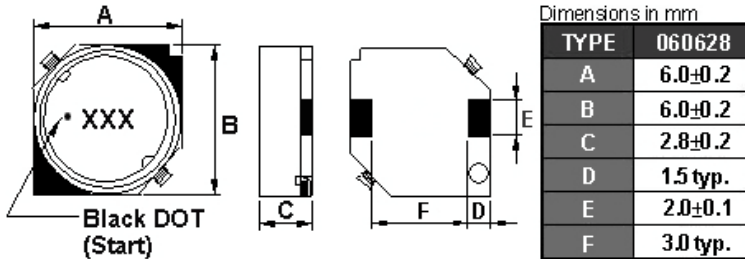

### Net Weight (grms)

SIZE CODE	Net Weight (grms)
060628	0.33(Typ.)

### 7 Electrical Characteristics:

Part No.	Inductance (μH)	Test Freq.	RDC (Ω)	Isat (A)	Irms (A)Max.	Tolerance (±%)	Marking
BPSF000606284R7□00	4.7	0.5V 1kHz	0.0284±20%	1.6	2.5	20	4R7
BPSF000606285R4□00	5.4	0.5V 1kHz	0.033±20%	1.5	2	20	5R4
BPSF000606286R8□00	6.8	0.5V 1kHz	0.0354±20%	1.5	2.2	20	6R8
BPSF00060628100□00	10	0.5V 1kHz	0.0532±20%	1.3	1.8	20	100
BPSF00060628150□00	15	0.5V 1kHz	0.0745±20%	1	1.4	20	150
BPSF00060628220□00	22	0.5V 1kHz	0.104±20%	0.77	1.3	20	220
BPSF00060628330□00	33	0.5V 1kHz	0.148±20%	0.69	1.1	20	330
BPSF00060628470□00	47	0.5V 1kHz	0.21±20%	0.59	0.92	20	470
BPSF00060628680□00	68	0.5V 1kHz	0.29±20%	0.5	0.78	20	680
BPSF00060628101□00	100	0.5V 1kHz	0.430±20%	0.42	0.64	20	101

**NOTE:** □-tolerance M=±20%

1. Operating temperature range - 4 0°C ~ 1 2 5°C(Including self - temperature rise)

2. Isat for Inductance drop 30% from its value without current.

3. I rms for a 25°C temperature rise from 25°C ambient.

## BPSF00060628 Series Specification

### 8 BPSF00060628 Series

#### 8.1 Construction:

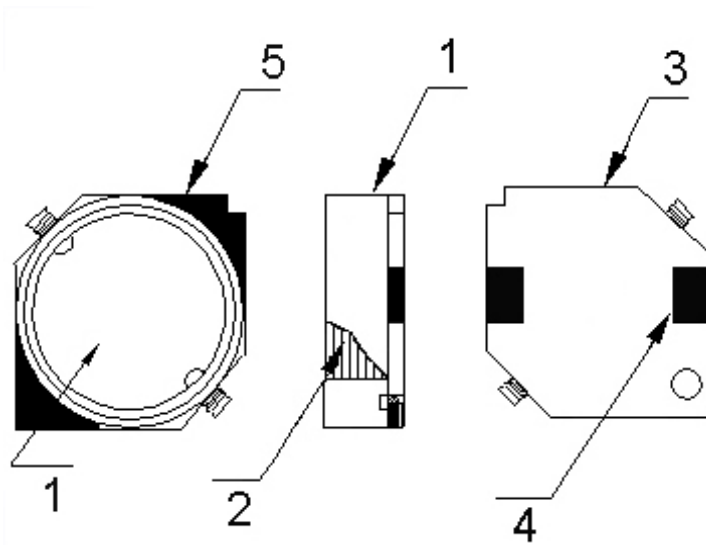

#### 8.2 Material List:

No	Part	Material
1	CORE	FERRITE
2	WIRE	MAGNET WIRE
3	BASE	LCP
4	TERMINAL	
5	EPOXY	

## BPSF00060628 Series Specification

### 9 Reliability Of Ferrite Wire Wound Power Inductor

#### 1-1.Mechanical Performance

No	Item	Specification	Test Method
1-1-1	Vibration	Appearance: No damage Inductance: within $\pm 10\%$ of initial value	Test device shall be soldered on the substrate Oscillation Frequency: 10 to 55 to 10Hz for 1min Amplitude: 1.5mm Time: 2hrs for each axis (X, Y & Z), total 6hrs
1-1-2	Resistance to Soldering Heat	Appearance: No damage	Pre-heating: 150°C, 1min Solder Composition: Sn/Ag3.0/Cu0.5 Solder Temperature: 260 $\pm$ 5°C Immersion Time: 10 $\pm$ 1sec
1-1-3	Solder ability	The electrodes shall be at least 95% covered with new solder coating	Pre-heating: 150°C, 1min Solder Composition: Sn/Ag3.0/Cu0.5 Solder Temperature: 245 $\pm$ 5°C Immersion Time: 4 $\pm$ 1sec
1-1-4	Resistance to solvent	There must be no change in appearance or obliteration of marking.	Inductors must withstand 6 minutes of alcohol or water.

#### 1-2.Environmental Performance

No	Item	Specification	Test Method															
1-2-1	Temperature Shock	Appearance: No damage Inductance: within $\pm 10\%$ of initial value	10 cycles (Air to Air) 1 cycles shall consist of: 30 minutes exposure to -55 °C 30 minutes exposure to 125 °C 15 seconds maximum transition between temperatures															
1-2-2	Temperature Cycle		One cycle: <table border="1"> <thead> <tr> <th>Step</th> <th>Temperature (°C)</th> <th>Time (min)</th> </tr> </thead> <tbody> <tr> <td>1</td> <td>-40<math>\pm</math>3</td> <td>30</td> </tr> <tr> <td>2</td> <td>25<math>\pm</math>2</td> <td>3</td> </tr> <tr> <td>3</td> <td>125<math>\pm</math>3</td> <td>30</td> </tr> <tr> <td>4</td> <td>25<math>\pm</math>2</td> <td>3</td> </tr> </tbody> </table>	Step	Temperature (°C)	Time (min)	1	-40 $\pm$ 3	30	2	25 $\pm$ 2	3	3	125 $\pm$ 3	30	4	25 $\pm$ 2	3
Step	Temperature (°C)	Time (min)																
1	-40 $\pm$ 3	30																
2	25 $\pm$ 2	3																
3	125 $\pm$ 3	30																
4	25 $\pm$ 2	3																
1-2-3	Humidity Resistance		Total: 100cycles Measured after exposure in the room condition for 24hrs Temperature: 40 $\pm$ 2°C Relative Humidity: 90 ~ 95% Time: 1000hrs Measured after exposure in the room condition for 24hrs															
1-2-4	Heat Life		Temperature: 85 $\pm$ 3°C Applied Current: Rated Current Time: 1000hrs Measured after exposure in the room condition for 24hrs															
1-2-5	Cold Resistance		Temperature: -40 $\pm$ 3°C Time: 1000hrs Measured after exposure in the room condition for 24hrs															

## BPSF00060628 Series Specification

### Reflow Soldering Profile

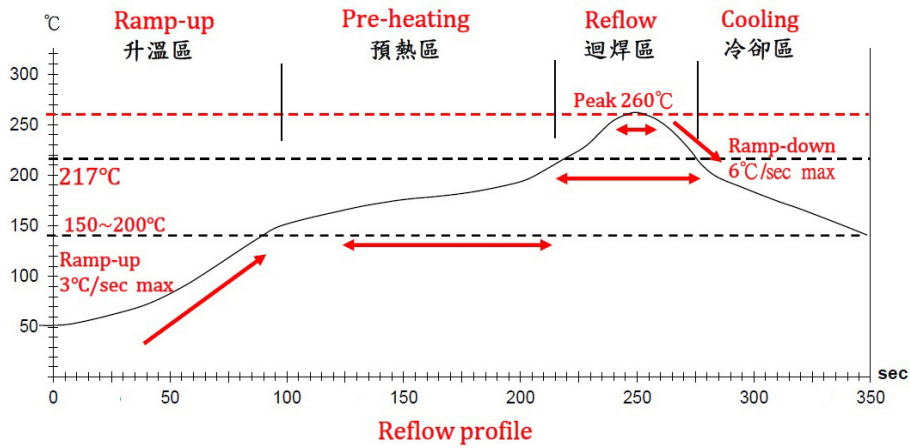

Lead-Free(LF)標準溫度分析範圍

Refer to J-STD-020C

管制項目 Item.	升溫區 Ramp-up	預熱區 Pre-heating	迴焊區 Reflow	Peak Temp	冷卻區 Cooling
溫度範圍 Temp.scope	R.T ~ 150°C	150°C ~ 200°C	217°C	260±5°C	Peak Temp.~150°C
標準時間 Time spec.	-	60 ~ 180 sec	60 ~ 150 sec	20 ~ 40 sec	-
實際時間 Time result	-	75 ~ 100 sec	90 ~ 120 sec	20 ~ 35 sec	-

## BPSF00060628 Series Specification

### 11 Packaging:

#### 11.1 Packaging -Cover Tape

The force for tearing off cover tape is 10 to 130 grams in the arrow direction.

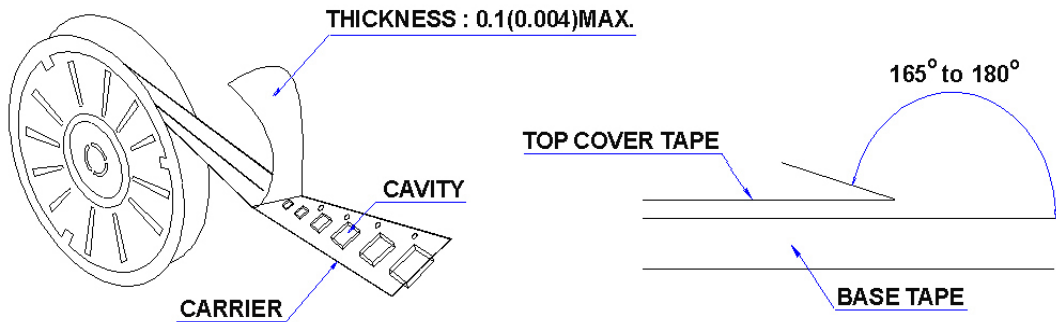

#### 11.2 Packaging Quantity

TYPE	PCS/REEL
060628	1000

#### 11.3 Reel Dimensions

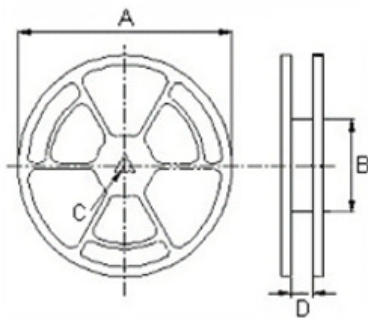

Dimensions in mm

TYPE	A	B	C	D
060628	330	100	13	16

## BPSF00060628 Series Specification

### 11 Packaging:

#### 11.4 Tape Dimensions in mm

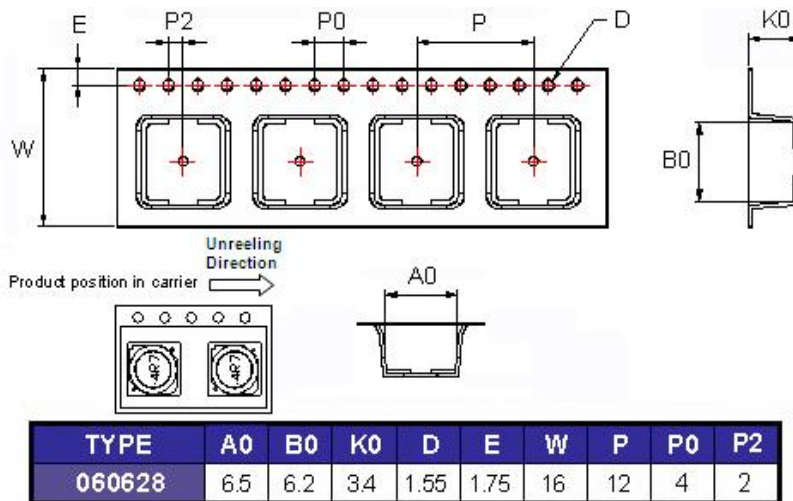

### 12 Recommended Land Pattern:

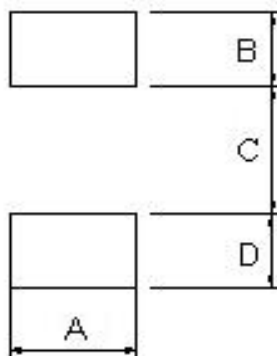

Dimensions in mm

TYPE	A	B	C	D
060628	2.2	1.7	2.8	1.7

### 13 Note:

1. Please make sure that your product has been evaluated and confirmed against your specifications when our product is mounted to your product.
2. Do not knock nor drop.
3. All the items and parameters in this product specification have been prescribed on the premise that our product is used for the purpose, under the condition and in the environment agreed upon between you and us. You are requested not to use our product deviating from such agreement.
4. Please keep the distance between transformer/coil and other components (refer to the standard IEC 950)
5. The moisture sensitivity level (MSL) of products is classified as level 1.

# BPSF00060628 Series Specification

**14** Graph:

BPSF000606284R7□00

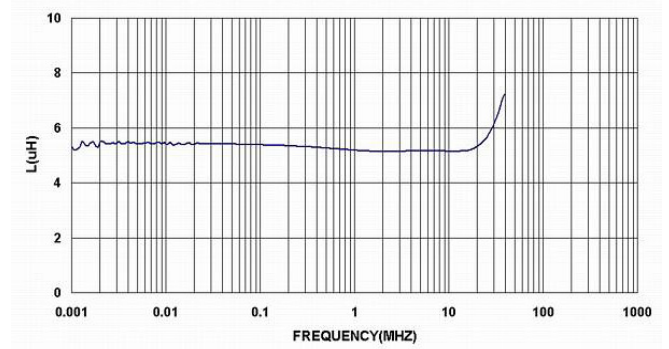
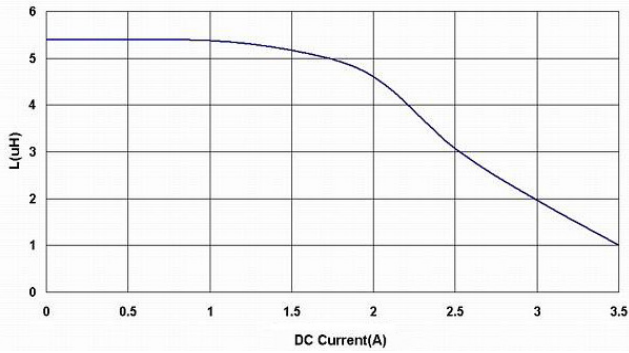

BPSF000606286R8□00

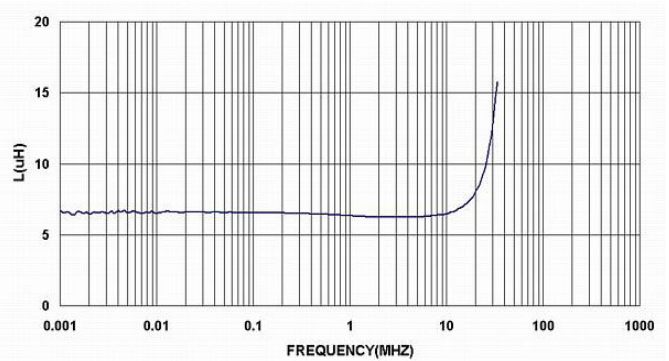
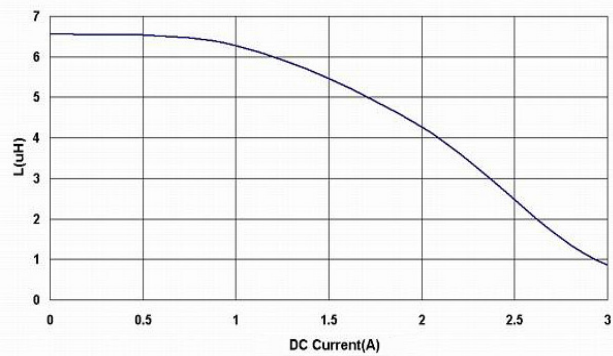

BPSF00060628100□00

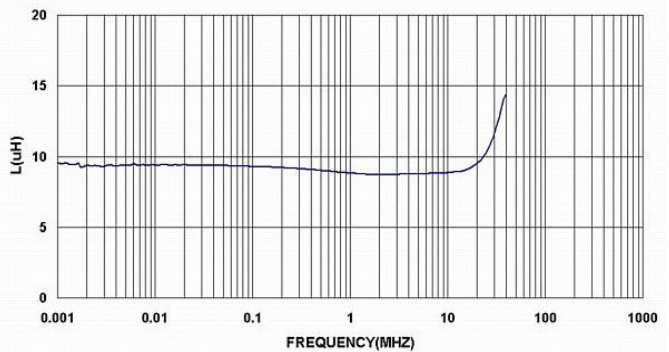
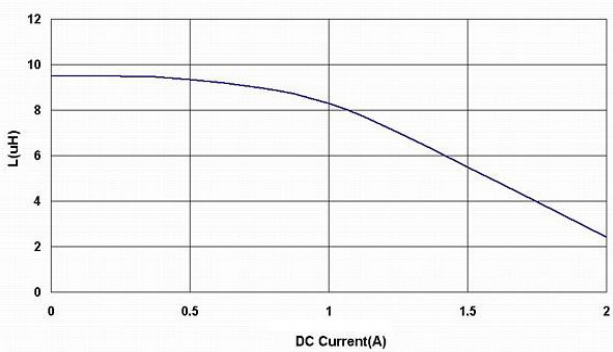

BPSF00060628101□00

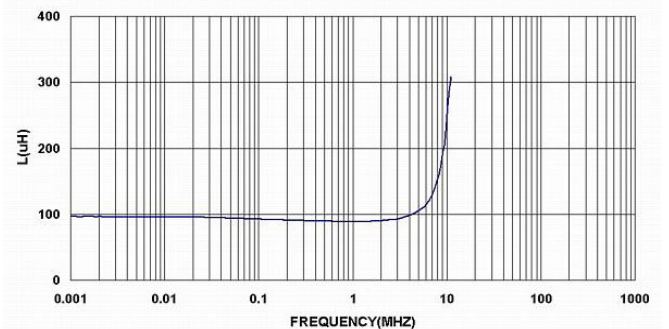
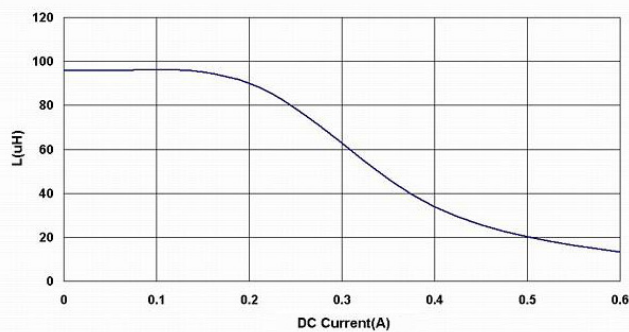

# BPSF00060628 Series Specification

**14** Graph:

BPSF00060628150□00

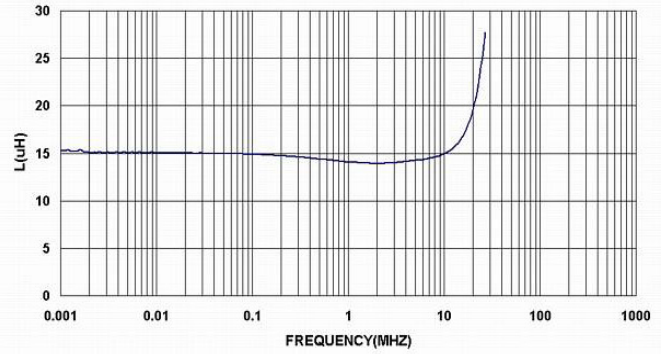
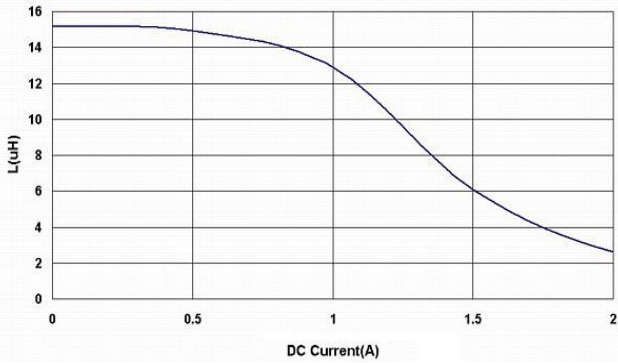

BPSF00060628220□00

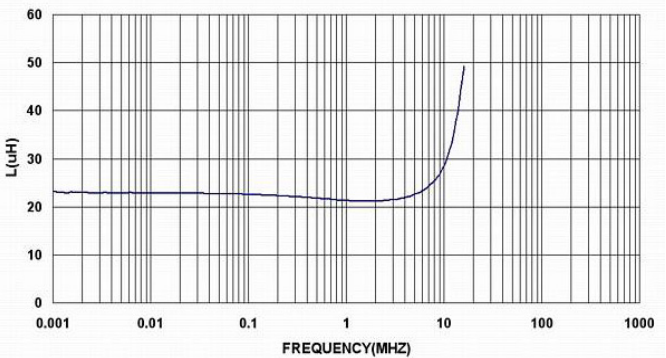
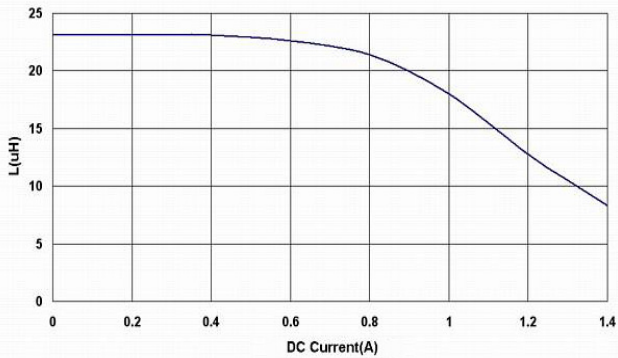

BPSF00060628330□00

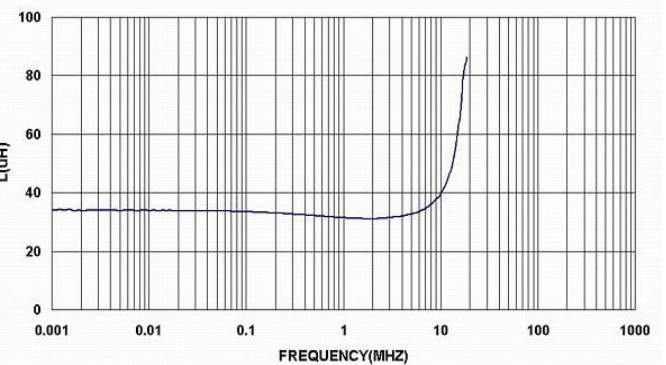
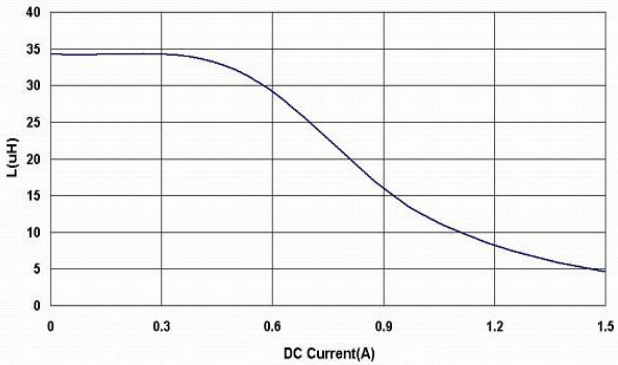

BPSF00060628470□00

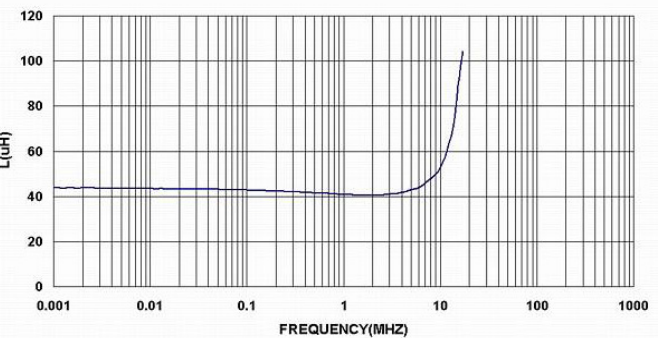
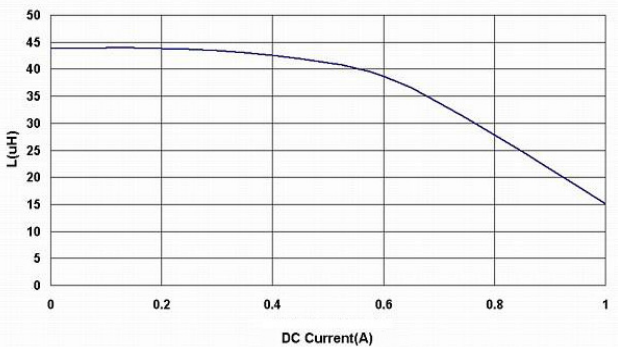

## BPSF00060628 Series Specification

### 14 Graph:

BPSF00060628680□00

