

NOTES:

1. ROHS COMPLIANT
2. HEADER: PHENOLIC WITH FLAMMABILITY RATING UL 94V-0 OR BETTER.
3. STORAGE TEMPERATURE: -50°C TO +125°C
4. COMPLIANCE TO J-STD:
 - A. J-STD-002: SOLDERABILITY AT 245°C REFLOW PROFILE
 - B. J-STD-020: LEVEL 1, NO MOISTURE SENSITIVE
 - C. J-STD-075: R7, 245°C MAXIMUM THROUGH REFLOW SOLDER
5. TO ORDER TAPE & REEL PACKAGING ADD A "T" SUFFIX TO THE PART NUMBER(i.e TX1267FNL BECOMES TX1267FNLT).

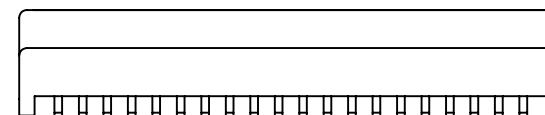
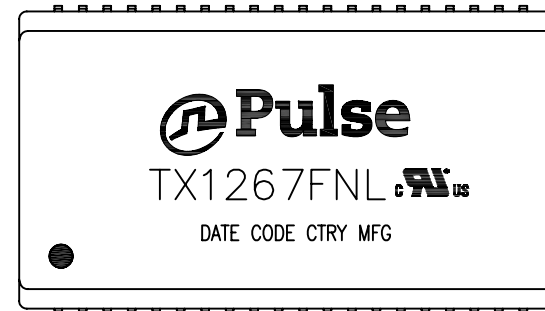

FINAL OUTLINE

© Copyright, 2014. Pulse Electronics Corp. All rights reserved. Pulse confidential & proprietary. (06/17/14)

PRODUCT DESCRIPTION	TLA DRAWING	PS DRAWING	SHEET	PART NO.	DATASHEET REV.
XFMR,OCTAL,T1,40-PIN TOU OPEN HEADER,1:2,1:1	TX1267FNL-10	PS-2743.001-A	1 OF 3	TX1267FNL	A

ELECTRICAL CHARACTERISTICS AT +25°C UNLESS OTHER SPECIFIED

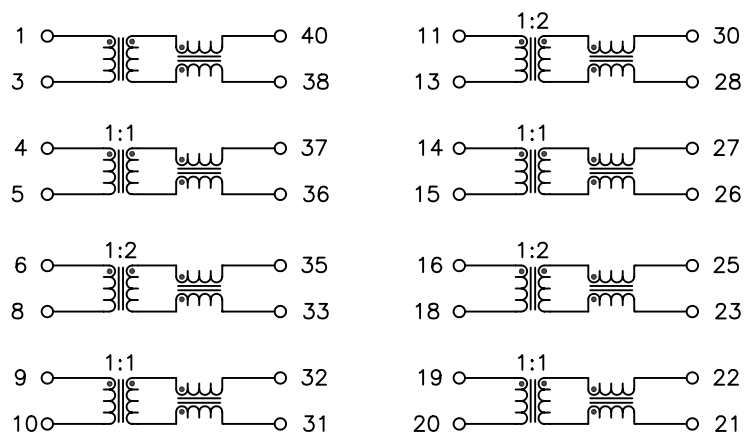

SCHEMATIC

PARAMETER	SPECIFICATIONS
OPERATING TEMPERATURE	-40°C ~ +85°C
POLARITY	PER SCHEMATIC
TURNS RATIO ◎ 100 KHZ, 0.1 VRMS	$\frac{(40-38)}{(1-3)} = \frac{(35-33)}{(6-8)} = \frac{(30-28)}{(11-13)} = \frac{(25-23)}{(16-18)} = 2.0 \pm 2\%$ $\frac{(37-36)}{(4-5)} = \frac{(32-31)}{(9-10)} = \frac{(27-26)}{(14-15)} = \frac{(22-21)}{(19-20)} = 1.0 \pm 2\%$
INDUCTANCE (OCL) ◎ 100 KHZ, 0.02 VRMS	$(40-38)=(37-36)=(35-33)=(32-31) = 1.20 \text{ mH MINIMUM}$ $(30-28)=(27-26)=(25-23)=(22-21) = 1.20 \text{ mH MINIMUM}$
LEAKAGE INDUCTANCE ◎ 100 KHZ, 0.02 VRMS	(1-3) WITH (40-38) SHORTED = 0.7 uH MAXIMUM (4-5) WITH (37-36) SHORTED = 0.7 uH MAXIMUM (6-8) WITH (35-33) SHORTED = 0.7 uH MAXIMUM (9-10) WITH (32-31) SHORTED = 0.7 uH MAXIMUM (11-13) WITH (30-28) SHORTED = 0.7 uH MAXIMUM (14-15) WITH (27-26) SHORTED = 0.7 uH MAXIMUM (16-18) WITH (25-23) SHORTED = 0.7 uH MAXIMUM (19-20) WITH (22-21) SHORTED = 0.7 uH MAXIMUM
CWW ◎ 100 KHZ, 1 VRMS	(1-3) TO (40-38) = 35 pF MAXIMUM (4-5) TO (37-36) = 35 pF MAXIMUM (6-8) TO (35-33) = 35 pF MAXIMUM (9-10) TO (32-31) = 35 pF MAXIMUM (11-13) TO (30-28) = 35 pF MAXIMUM (14-15) TO (27-26) = 35 pF MAXIMUM (16-18) TO (25-23) = 35 pF MAXIMUM (19-20) TO (22-21) = 35 pF MAXIMUM
DC RESISTANCE	$(40-38) = (37-36) = (35-33) = (32-31) = 1.2 \text{ OHMS MAXIMUM}$ $(30-28) = (27-26) = (25-23) = (22-21) = 1.2 \text{ OHMS MAXIMUM}$ $(1-3) = (4-5) = (6-8) = (9-10) = 0.8 \text{ OHMS MAXIMUM}$ $(11-13) = (14-15) = (16-18) = (19-20) = 0.8 \text{ OHMS MAXIMUM}$
HIPOT	1500 VRMS FOR 6 SECS

© Copyright, 2014. Pulse Electronics Corp. All rights reserved. Pulse confidential & proprietary. (06/17/14)

PRODUCT DESCRIPTION	TLA DRAWING	PS DRAWING	SHEET	PART NO.	DATASHEET REV.
XFMR,OCTAL,T1,40-PIN TOU OPEN HEADER,1:2,1:1	TX1267FNL-10	PS-2743.001-A	2 OF 3	TX1267FNL	A

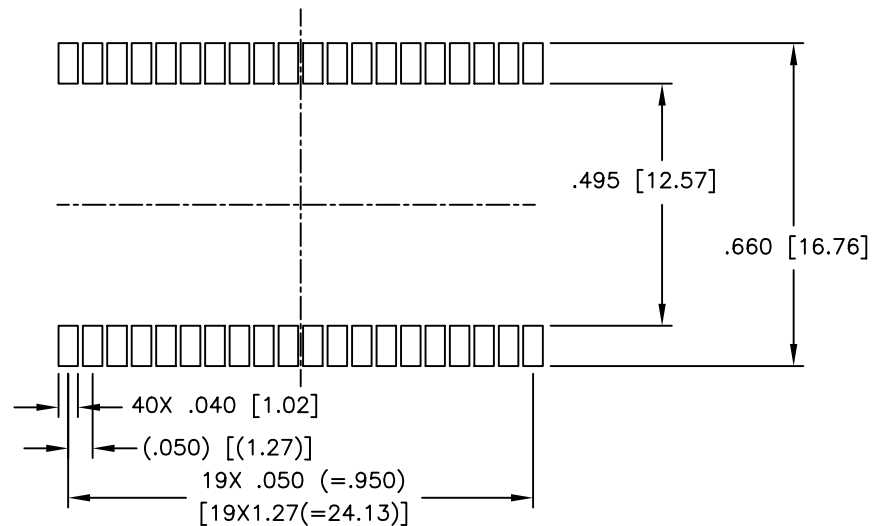
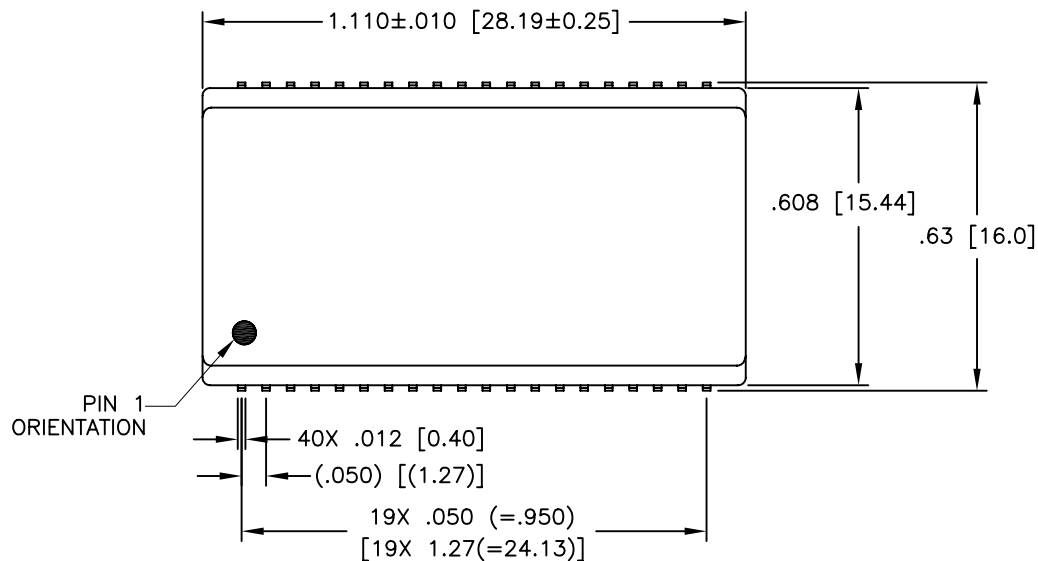

SUGGESTED PAD LAYOUT

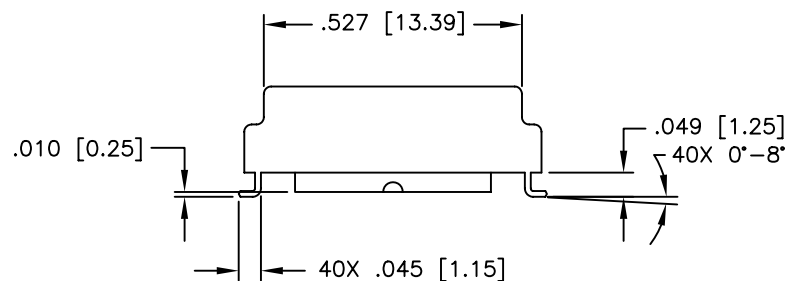
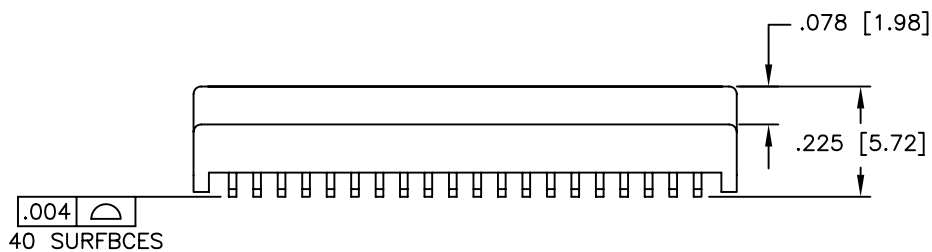

DIMENSIONS ARE IN INCHES [MILLIMETERS] WITH THE FOLLOWING TOLERANCES: [MILLIMETERS] ARE FOR REFERENCE ONLY.
 .XX= ±.01 [±0.25]
 .XXX= ±.005 [±0.13]

© Copyright, 2014. Pulse Electronics Corp. All rights reserved. Pulse confidential & proprietary. (06/17/14)

PRODUCT DESCRIPTION	TLA DRAWING	PS DRAWING	SHEET	PART NO.	DATASHEET REV.
XFMR,OCTAL,T1,40-PIN TOU OPEN HEADER,1:2,1:1	TX1267FNL-10	PS-2743.001-A	3 OF 3	TX1267FNL	A