

- ▼ 100% R<sub>g</sub> & UIS Test
- ▼ Fast Switching Characteristic
- ▼ Simple Drive Requirement
- ▼ RoHS Compliant & Halogen-Free

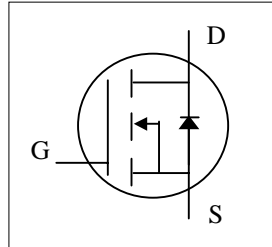

BV <sub>DSS</sub>	650V
R <sub>DS(ON)</sub>	0.13 Ω
I <sub>D</sub> <sup>3,4</sup>	26.2A

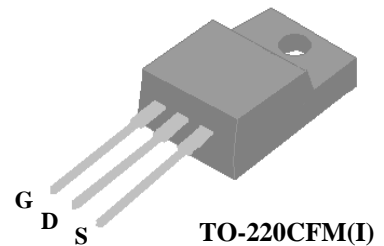

## Description

XP65SL130D series are innovated design and silicon process technology to achieve the lowest possible on-resistance and fast switching performance. It provides the designer with an extreme efficient device for use in a wide range of power applications.

The TO-220CFM package is widely preferred for all commercial-industrial through hole applications. The mold compound provides a high isolation voltage capability and low thermal resistance between the tab and the external heat-sink

## Absolute Maximum Ratings

Symbol	Parameter	Rating	Units
V <sub>DS</sub>	Drain-Source Voltage	650	V
V <sub>GS</sub>	Gate-Source Voltage	±20	V
V <sub>GS</sub>	Gate-Source Voltage, AC (f > 1Hz)	±30	V
I <sub>D</sub> @T <sub>C</sub> =25°C	Drain Current, V <sub>GS</sub> @ 10V <sup>3,4</sup>	26.2	A
I <sub>D</sub> @T <sub>C</sub> =100°C	Drain Current, V <sub>GS</sub> @ 10V <sup>3,4</sup>	16.5	A
I <sub>DM</sub>	Pulsed Drain Current <sup>1</sup>	66	A
dv/dt	MOSFET dv/dt Ruggedness (V <sub>DS</sub> = 0 ...480V )	20	V/ns
P <sub>D</sub> @T <sub>C</sub> =25°C	Total Power Dissipation	33.7	W
P <sub>D</sub> @T <sub>A</sub> =25°C	Total Power Dissipation	1.92	W
E <sub>AS</sub>	Single Pulse Avalanche Energy <sup>5</sup>	300	mJ
dv/dt	Peak Diode Recovery dv/dt <sup>6</sup>	15	V/ns
T <sub>STG</sub>	Storage Temperature Range	-55 to 150	°C
T <sub>J</sub>	Operating Junction Temperature Range	-55 to 150	°C

## Thermal Data

Symbol	Parameter	Value	Units
R <sub>thj-c</sub>	Maximum Thermal Resistance, Junction-case	3.7	°C/W
R <sub>thj-a</sub>	Maximum Thermal Resistance, Junction-ambient	65	°C/W

**Electrical Characteristics @T<sub>j</sub>=25°C(unless otherwise specified)**

Symbol	Parameter	Test Conditions	Min.	Typ.	Max.	Units
BV <sub>DSS</sub>	Drain-Source Breakdown Voltage	V <sub>GS</sub> =0V, I <sub>D</sub> =250uA	650	-	-	V
R <sub>DS(ON)</sub>	Static Drain-Source On-Resistance <sup>2</sup>	V <sub>GS</sub> =10V, I <sub>D</sub> =9.6A	-	-	0.13	Ω
V <sub>GS(th)</sub>	Gate Threshold Voltage	V <sub>DS</sub> =V <sub>GS</sub> , I <sub>D</sub> =250uA	2	-	5	V
g <sub>fs</sub>	Forward Transconductance	V <sub>DS</sub> =15V, I <sub>D</sub> =9.6A	-	17	-	S
I <sub>DSS</sub>	Drain-Source Leakage Current	V <sub>DS</sub> =520V, V <sub>GS</sub> =0V	-	-	100	uA
I <sub>GSS</sub>	Gate-Source Leakage	V <sub>GS</sub> =±20V, V <sub>DS</sub> =0V	-	-	±1	uA
Q <sub>g</sub>	Total Gate Charge	I <sub>D</sub> =14A	-	88	140.8	nC
Q <sub>gs</sub>	Gate-Source Charge	V <sub>DS</sub> =480V	-	20	-	nC
Q <sub>gd</sub>	Gate-Drain ("Miller") Charge	V <sub>GS</sub> =10V	-	38	-	nC
t <sub>d(on)</sub>	Turn-on Delay Time	V <sub>DD</sub> =300V	-	23	-	ns
t <sub>r</sub>	Rise Time	I <sub>D</sub> =14A	-	36	-	ns
t <sub>d(off)</sub>	Turn-off Delay Time	R <sub>G</sub> =3.3Ω	-	82	-	ns
t <sub>f</sub>	Fall Time	V <sub>GS</sub> =10V	-	32	-	ns
C <sub>iss</sub>	Input Capacitance	V <sub>GS</sub> =0V	-	3200	5120	pF
C <sub>oss</sub>	Output Capacitance	V <sub>DS</sub> =100V	-	90	-	pF
C <sub>rss</sub>	Reverse Transfer Capacitance	f=1.0MHz	-	7	-	pF
R <sub>g</sub>	Gate Resistance	f=1.0MHz	-	4.2	8.4	Ω

**Source-Drain Diode**

Symbol	Parameter	Test Conditions	Min.	Typ.	Max.	Units
V <sub>SD</sub>	Forward On Voltage <sup>2</sup>	I <sub>S</sub> =9.6A, V <sub>GS</sub> =0V	-	0.85	-	V
t <sub>rr</sub>	Reverse Recovery Time	I <sub>S</sub> =14A, V <sub>GS</sub> =0V	-	170	-	ns
Q <sub>rr</sub>	Reverse Recovery Charge	di/dt=100A/μs	-	1.5	-	μC

**Notes:**

- 1.Pulse width limited by max. junction temperature.
- 2.Pulse test
- 3.Limited by max. junction temperature. Maximum duty cycle D=0.75
- 4.Ensure that the junction temperature does not exceed T<sub>Jmax</sub>.
- 5.Starting T<sub>j</sub>=25°C , V<sub>DD</sub>=50V , L=150mH , R<sub>G</sub>=25Ω
- 6.I<sub>SD</sub> ≤ I<sub>D</sub>, V<sub>DD</sub> ≤ BV<sub>DSS</sub>, starting T<sub>J</sub> = 25°C

THIS PRODUCT IS SENSITIVE TO ELECTROSTATIC DISCHARGE, PLEASE HANDLE WITH CAUTION.

USE OF THIS PRODUCT AS A CRITICAL COMPONENT IN LIFE SUPPORT OR OTHER SIMILAR SYSTEMS IS NOT AUTHORIZED.

XSEMI DOES NOT ASSUME ANY LIABILITY ARISING OUT OF THE APPLICATION OR USE OF ANY PRODUCT OR CIRCUIT DESCRIBED HEREIN; NEITHER DOES IT CONVEY ANY LICENSE UNDER ITS PATENT RIGHTS, NOR THE RIGHTS OF OTHERS.

XSEMI RESERVES THE RIGHT TO MAKE CHANGES WITHOUT FURTHER NOTICE TO ANY PRODUCTS HEREIN TO IMPROVE RELIABILITY, FUNCTION OR DESIGN.

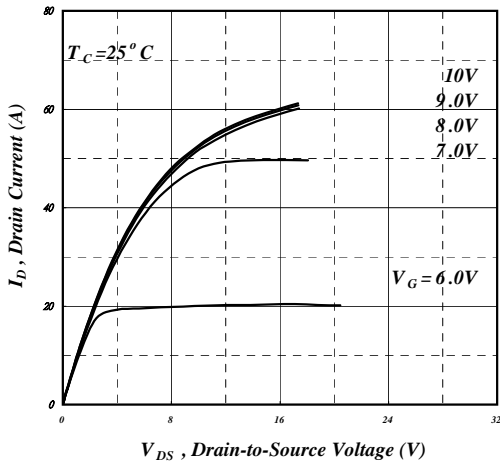

**Fig 1. Typical Output Characteristics**

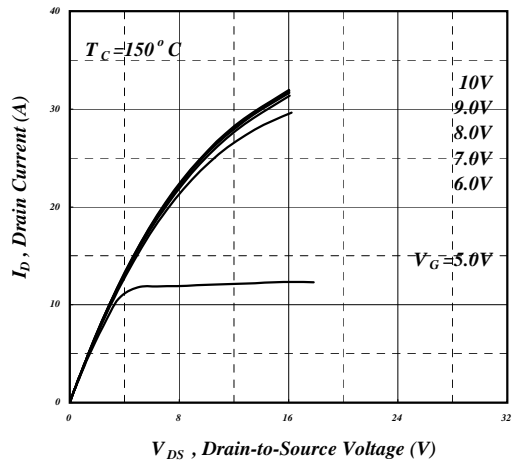

**Fig 2. Typical Output Characteristics**

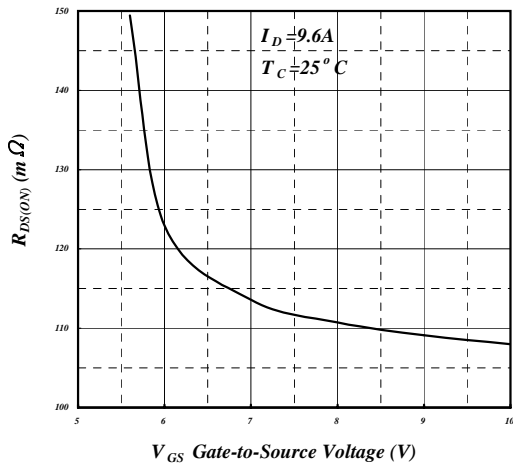

**Fig 3. On-Resistance v.s. Gate Voltage**

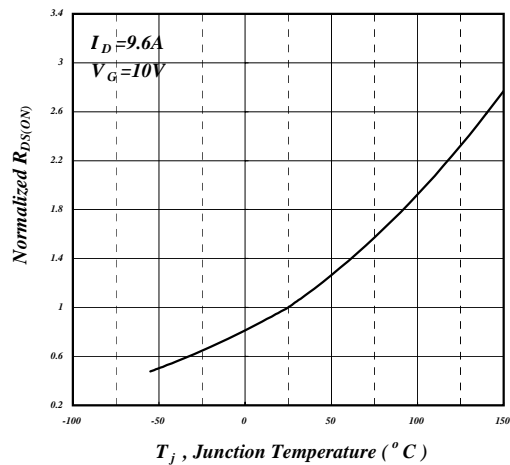

**Fig 4. Normalized On-Resistance v.s. Junction Temperature**

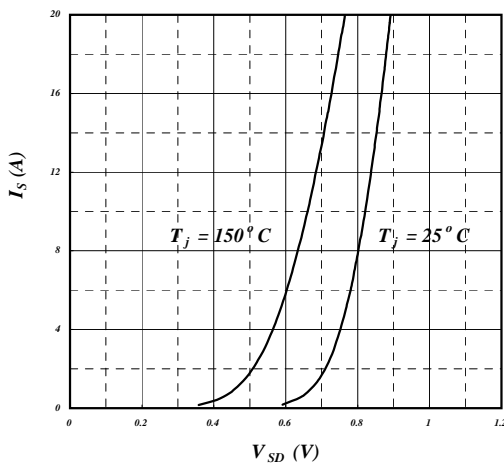

**Fig 5. Forward Characteristic of Reverse Diode**

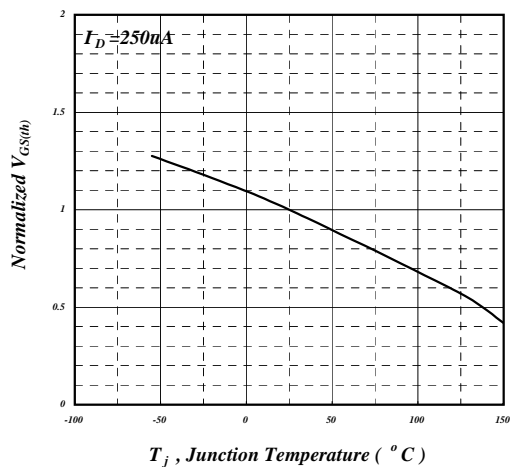

**Fig 6. Gate Threshold Voltage v.s. Junction Temperature**

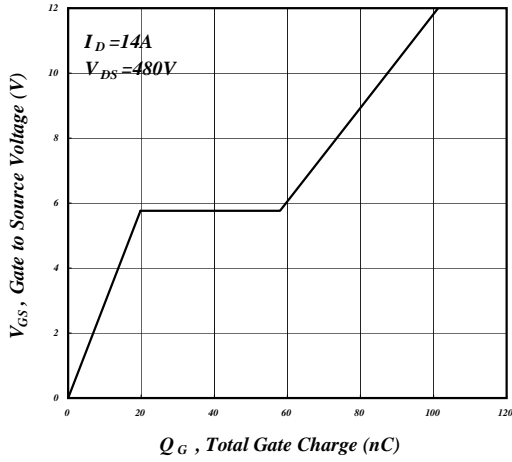

**Fig 7. Gate Charge Characteristics**

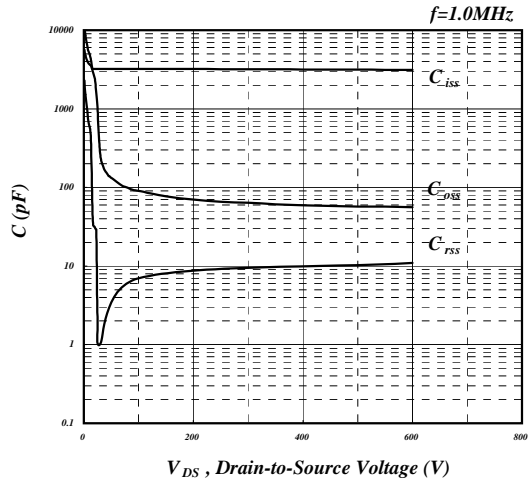

**Fig 8. Typical Capacitance Characteristics**

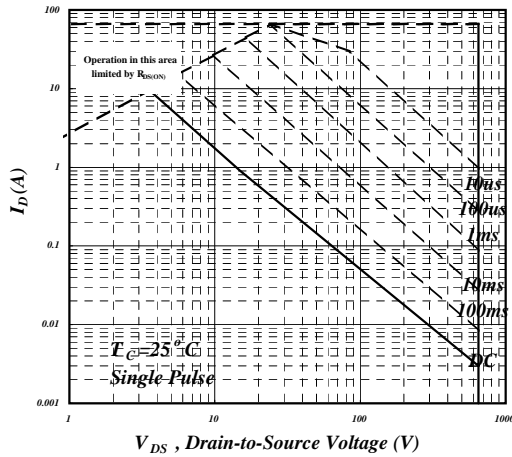

**Fig 9. Maximum Safe Operating Area**

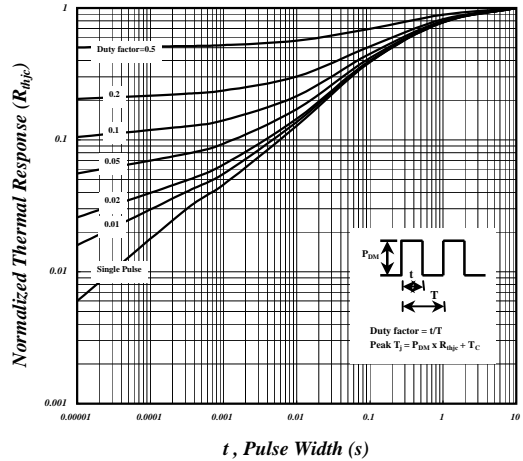

**Fig 10. Effective Transient Thermal Impedance**

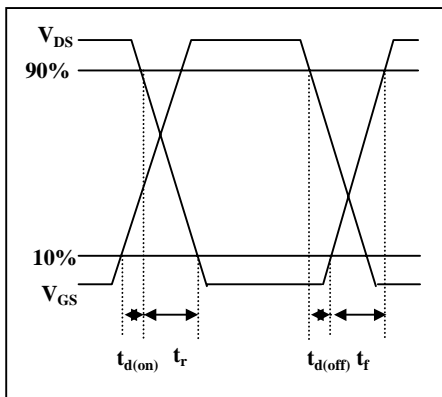

**Fig 11. Switching Time Waveform**

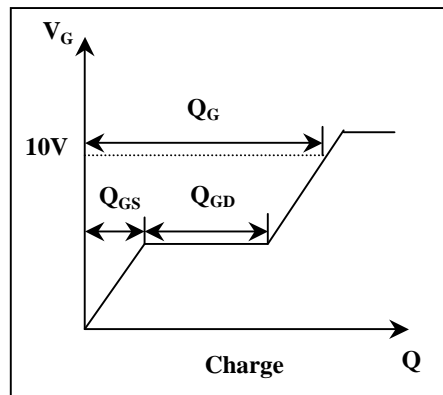

**Fig 12. Gate Charge Waveform**

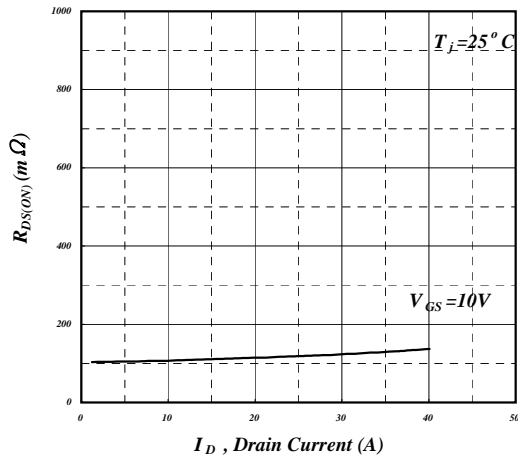

**Fig 13. Typ. Drain-Source on State Resistance**

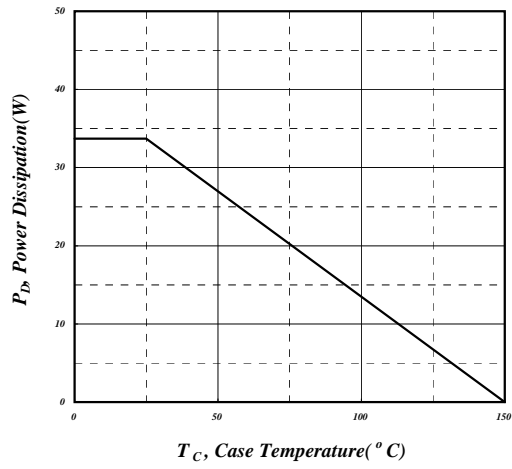

**Fig 14. Total Power Dissipation**

---

**MARKING INFORMATION**

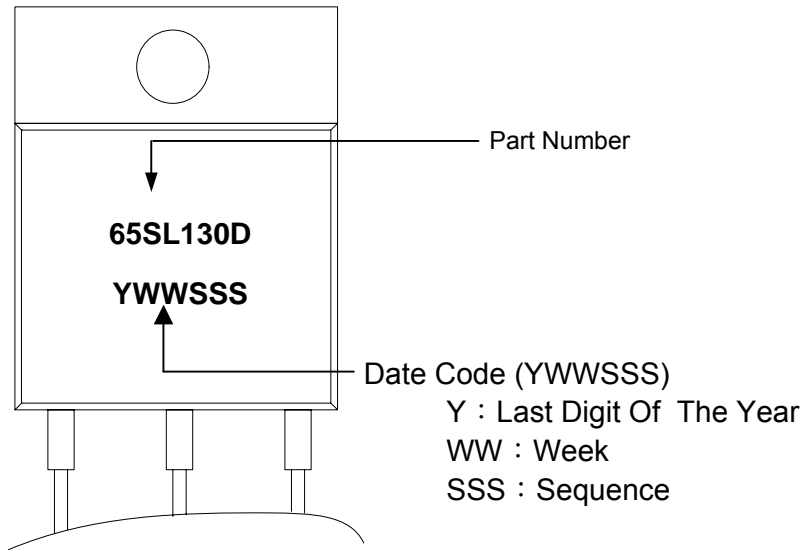

**Package Outline : TO-220CFM**

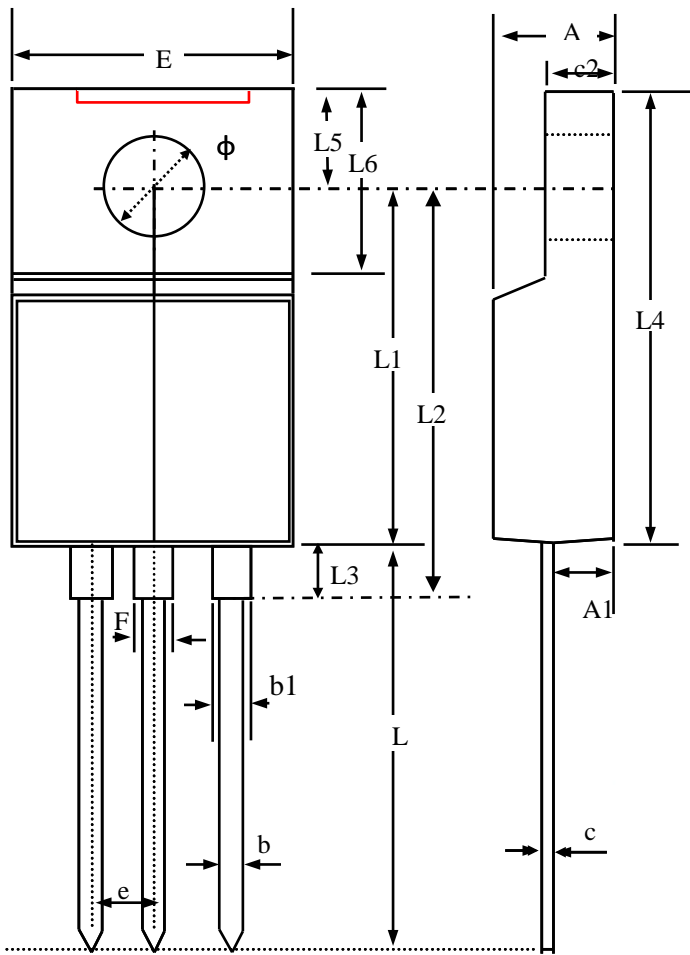

SYMBOLS	Millimeters		
	MIN	NOM	MAX
<b>A</b>	4.40	4.65	4.90
<b>A1</b>	2.50	2.68	2.86
<b>b</b>	0.70	0.84	0.98
<b>b1</b>	1.10	1.30	1.50
<b>c</b>	0.45	0.54	0.63
<b>c2</b>	2.34	2.54	2.74
<b>E</b>	10.00	10.20	10.40
<b>L</b>	12.78	13.22	13.65
<b>L1</b>	12.45	12.70	12.95
<b>L2</b>	15.10	15.80	16.50
<b>L3</b>	2.83	3.22	3.60
<b>L4</b>	15.67	16.04	16.40
<b>L5</b>	3.20	3.30	3.40
<b>L6</b>	6.50	6.73	6.95
$\phi$	3.00	3.14	3.28
<b>e</b>	2.40	2.55	2.70
<b>F</b>	1.15	1.33	1.50

1. All Dimensions Are in Millimeters.
2. Dimension Does Not Include Mold Protrusions.

**TO-220CFM FOOTPRINT :**

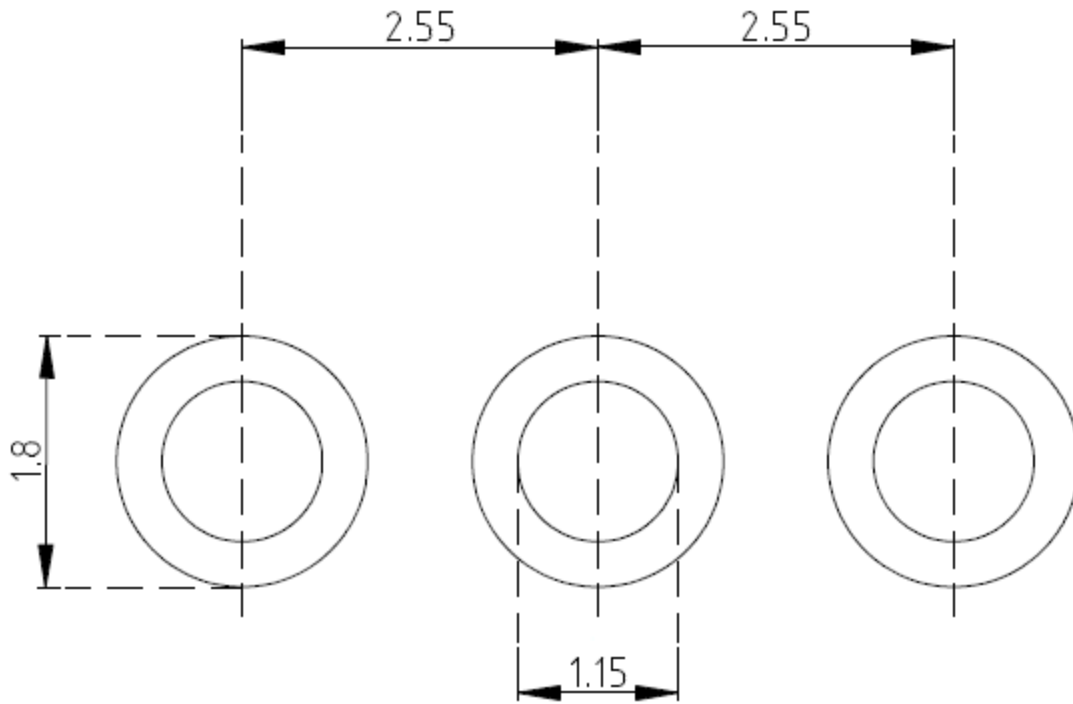

UNIT: mm