

ALV70E131DE700

ALV70, Aluminum, Aluminum Electrolytic, 130 uF, 20%, 700 VDC, -25/+85°C, 22.5 mm

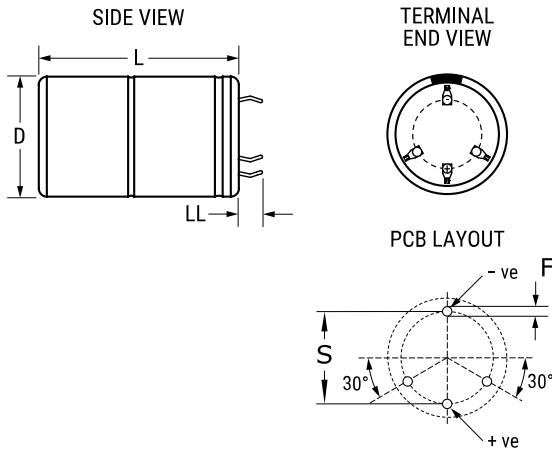

Click [here](#) for the 3D model.

General Information

Series	ALV70
Dielectric	Aluminum Electrolytic
Description	Snap-In, Aluminum Electrolytic
RoHS	Yes
Lead	4 Pin Short
Halogen Free	Yes
Typical Component Weight	75 g
Shelf Life	156 Weeks

Dimensions

D	35mm +1mm
L	45mm +/-2mm
S	22.5mm +/-0.1mm
LL	4mm +/-1mm
F	2mm +/-0.1mm

Packaging Specifications

Packaging	Tray
-----------	------

Specifications

Capacitance	130 uF
Tolerance	20%
Voltage DC	700 VDC
Temperature Range	-25/+85°C
Rated Temperature	85°C
Life	2000 Hrs
ESR	4384 mOhms (100Hz 20C), 4085 mOhms (10kHz 20C)
Ripple Current	1.04 Amps (100Hz 85C), 1.25 Amps (10kHz 85C)
Leakage Current	546 uA (5min 20°C)

Statements of suitability for certain applications are based on our knowledge of typical operating conditions for such applications, but are not intended to constitute - and we specifically disclaim - any warranty concerning suitability for a specific customer application or use. This Information is intended for use only by customers who have the requisite experience and capability to determine the correct products for their application. Any technical advice inferred from this Information or otherwise provided by us with reference to the use of our products is given gratis, and we assume no obligation or liability for the advice given or results obtained.