

# SSR10H-17058

Aliases (UALR10H1705800)

Common Mode Chokes - Power, KEMET, SSR10V/H, Through-Hole Bobbin, Common Mode, 5,800 uH

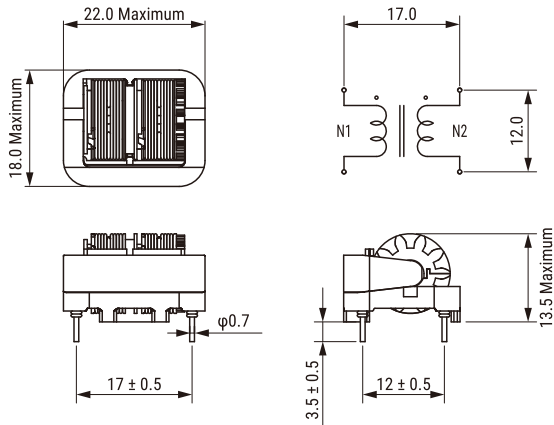

Click [here](#) for the 3D model.

## General Information

Series	SSR10V/H
Style	Through-Hole Bobbin
Features	Small Standard Common Mode, High Permeability, Compact Size, Low Profile, Light Weight, High Impedance, Strong Inductance
RoHS	Yes
Miscellaneous	60 (K) Temperature Rise Max.
Core	Mn-Zn Ferrite

## Dimensions

L	22mm MAX
T	18mm MAX
H	13.5mm MAX
LL	3.5mm +/-0.5mm
S	17mm +/-0.5mm
S1	12mm +/-0.5mm
Wire Size	0.4mm
F	0.7mm NOM

## Specifications

Voltage AC	250 VAC
Inductance	5.8 mH
Rated Current	1.7 A
Temperature Range	-40/+120°C
DC Resistance	0.18 Ohms

## Packaging Specifications

Packaging	Tray
Packaging Quantity	300
Typical Component Weight	9 g

Statements of suitability for certain applications are based on our knowledge of typical operating conditions for such applications, but are not intended to constitute - and we specifically disclaim - any warranty concerning suitability for a specific customer application or use. This Information is intended for use only by customers who have the requisite experience and capability to determine the correct products for their application. Any technical advice inferred from this Information or otherwise provided by us with reference to the use of our products is given gratis, and we assume no obligation or liability for the advice given or results obtained.