

ST-101F2

Aliases (UDLST00101F200)

Common Mode Chokes - Signal, KEMET, ST, Through-Hole, Common Mode

General Information

Series	ST
Style	Through-Hole
RoHS	Yes
Miscellaneous	AM Band, Frequency Range: 0.5 To 7 MHz, Impedance: 40000 Ohms (600 kHz).

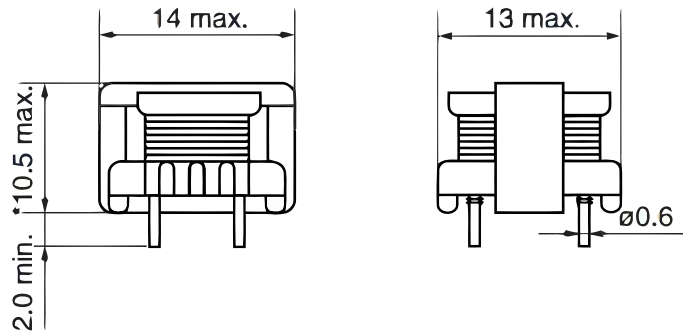

*11.5 max. with ST-101F4

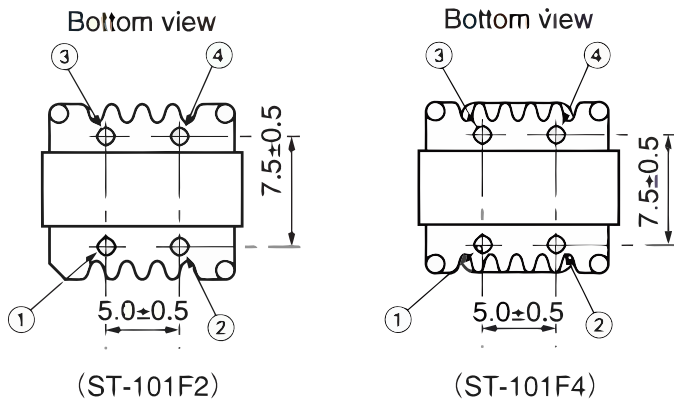

Click [here](#) for the 3D model.

Dimensions

L	14mm MAX
W	13mm MAX
H	10.5mm MAX
LL	2mm MIN
S	7.5mm +/-0.5mm
S1	5mm +/-0.5mm
F	0.6mm NOM

Specifications

Voltage DC	50 VDC
Temperature Range	-20/+75°C
DC Resistance	2.7 Ohms (per Line MAX)

Packaging Specifications

Packaging	Tray, Box
Packaging Quantity	1600
Typical Component Weight	2.9 g

Statements of suitability for certain applications are based on our knowledge of typical operating conditions for such applications, but are not intended to constitute - and we specifically disclaim - any warranty concerning suitability for a specific customer application or use. This Information is intended for use only by customers who have the requisite experience and capability to determine the correct products for their application. Any technical advice inferred from this Information or otherwise provided by us with reference to the use of our products is given gratis, and we assume no obligation or liability for the advice given or results obtained.