

T495X157K010AH4095

Aliases (DLA Drawing 95158-08KH)

T495 HRA, Tantalum, MnO2 Tantalum, HRA, 150 uF, 10%, 10 VDC, SMD, MnO2, Molded, Low ESR, High Reliability, N/A, 100 mOhms, 4.3 mm, 2817 / 7343

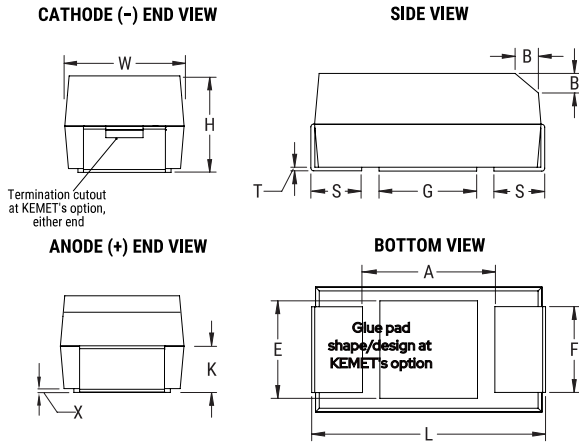

Click [here](#) for the 3D model.

General Information

Series	T495 HRA
Dielectric	MnO2 Tantalum
Style	SMD Chip
Description	SMD, MnO2, Molded, Low ESR, High Reliability
Features	Low ESR, High Reliability
RoHS	No
Prop 65	WARNING: Cancer and reproductive harm - https://www.p65warnings.ca.gov/
SCIP Number	1dd2e1b8-26dd-4d52-927c-6f9d519011aa
Termination	Tin Lead (SnPb)
Typical Component Weight	652.04 mg
MSL	1

Dimensions

L	7.3mm +/-0.3mm
W	4.3mm +/-0.3mm
H	4mm +/-0.3mm
T	0.13mm REF
S	1.3mm +/-0.3mm
F	2.4mm +/-0.1mm
A	3.8mm MIN
B	0.5mm +/-0.15mm
E	3.5mm REF
G	3.5mm REF
K	2.3mm +/-0.2mm
P	1.7mm REF
R	1mm REF
X	0.1mm +/-0.1mm REF

Packaging Specifications

Packaging	T&R, 178mm
Packaging Quantity	500

Specifications

Capacitance	150 uF
Tolerance	10%
Voltage DC	10 VDC (85C), 6.7 VDC (125C)
Temperature Range	-55/+125°C
Rated Temperature	85°C
Dissipation Factor	8% 120Hz 25C
Failure Rate	N/A
ESR	100 mOhms (100kHz 25C)
Ripple Current	1285 mA (rms, 100kHz 25C), 1157 mA (rms, 100kHz 85C), 514 mA (rms, 100kHz 125C)
Leakage Current	15 uA (5min 25°C)
Testing and Reliability	Tested To Meet The Established Reliability

Statements of suitability for certain applications are based on our knowledge of typical operating conditions for such applications, but are not intended to constitute - and we specifically disclaim - any warranty concerning suitability for a specific customer application or use. This Information is intended for use only by customers who have the requisite experience and capability to determine the correct products for their application. Any technical advice inferred from this Information or otherwise provided by us with reference to the use of our products is given gratis, and we assume no obligation or liability for the advice given or results obtained.